

Product availability: Non-Stock - Not normally stocked in distribution facility

Price\*: 72.85 USD



### Main

Range of Product	Modicon M171/M172
Product or Component Type	Additional I/O module
Product Specific Application	HVAC and pumping solution
Number of inputs/outputs	15
Discrete input number	6
Discrete output number	1 open collector 3 relay outputs SPST with same common
Discrete output current	2 A relay
Analogue input number	3 analog input NTC
Analogue output number	1 PWM/PPM 20 kHz, 12 V, 35 mA 2

### Complementary

Number of port	1 LAN expansion bus
Input/output number	3 analog input 2 analog output 6 digital input 4 digital output
Discrete input logic	Sink or source (positive/negative)
Contacts usage	Volt-free contacts
Analogue input type	Voltage 0...5 V ratiometric) Voltage 0...10 V NTC temperature probe - 50...100 °C 0.1 °C Current 0...20 mA/4...20 mA Voltage 0...1 V
Sensor power supply	12 V DC 85 mA
[Us] rated supply voltage	12...24 V +/- 20 % AC/DC 24 V +/- 20 % DC
Power consumption in W	18 W 24...48 V AC/DC
Realtime clock	Built-in 14...131 °F (-10...55 °C)
Display type	Without Display
Overvoltage category	II

Local signalling	For programmable 1 LED (red) For programmable 1 LED (yellow) for programmable 1 LED (green)
Maximum Width	5.51 In (140 mm)
Maximum Height	4.33 In (110 mm)
Maximum Depth	2.43 In (61.6 mm)
Net Weight	0.85 Lb(US) (0.385 kg)

## Environment

Directives	2006/95/EC - low voltage directive 86/188/EEC - physical agents (noise) directive
Standards	EN/IEC 60730
Product Certifications	CURus EAC CSA CE
Ambient air temperature for operation	14...131 °F (-10...55 °C) UL 60730-1
Ambient Air Temperature for Storage	-4...185 °F (-20...85 °C)
Relative humidity	10...90 % non-condensing
IP degree of protection	IP20
Pollution degree	2



## Ordering and shipping details

Category	22537 - M171 / M172 HVAC CONTROLLERS
Discount Schedule	PC12
GTIN	03606480752681
Nbr. of units in pkg.	1
Package weight(Lbs)	9.17 Oz (260 g)
Returnability	No
Country of origin	IT

## Packing Units

Unit Type of Package 1	PCE
Package 1 Height	5.12 In (13 cm)
Package 1 width	3.58 In (9.1 cm)
Package 1 Length	7.28 In (18.5 cm)
Unit Type of Package 2	S02
Number of Units in Package 2	6
Package 2 Weight	4.17 Lb(US) (1.891 kg)
Package 2 Height	5.91 In (15 cm)
Package 2 width	11.81 In (30 cm)
Package 2 Length	15.75 In (40 cm)

## Offer Sustainability

Sustainable offer status	Green Premium product
California proposition 65	WARNING: This product can expose you to chemicals including: Lead and lead compounds, which is known to the State of California to cause cancer and birth defects or other reproductive harm. For more information go to <a href="http://www.P65Warnings.ca.gov">www.P65Warnings.ca.gov</a>
REACH Regulation	 <a href="#">REACH Declaration</a>
REACH free of SVHC	Yes
EU RoHS Directive	Pro-active compliance (Product out of EU RoHS legal scope)  <a href="#">EU RoHS Declaration</a>
Mercury free	Yes
RoHS exemption information	 Yes

China RoHS Regulation	<a href="#">China RoHS Declaration</a>
Environmental Disclosure	<a href="#">Product Environmental Profile</a>
Circularity Profile	<a href="#">End Of Life Information</a>
WEEE	The product must be disposed on European Union markets following specific waste collection and never end up in rubbish bins.

Dimensions

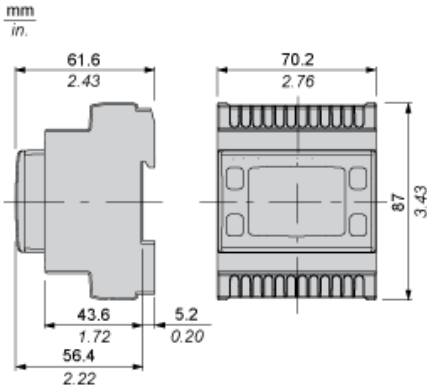

Mounting and Clearance

Clearance

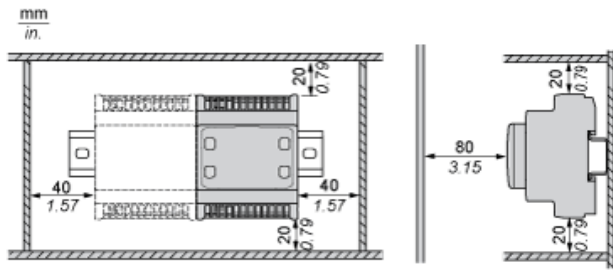

Misplacement

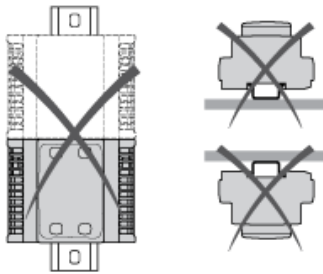

Power Supply

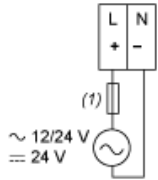

(1) Type T fuse (Controller: 1.25 A , Expansion: 1 A)

Wiring Diagram

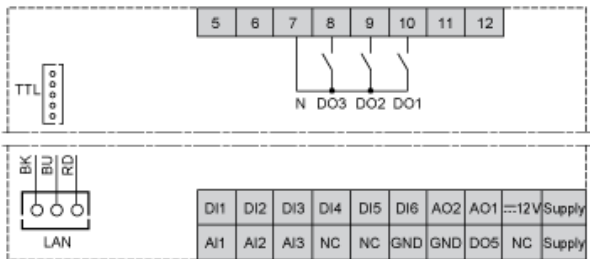
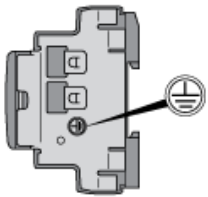

N : Neutral  
 GND Ground  
 BK : Black  
 BU : Blue  
 RD : Red  
 AI : Analogue input  
 AO : Analogue output  
 DI : Digital input  
 DO : Digital output  
 NC : No Connection

Product Life Status : **Commercialised**